

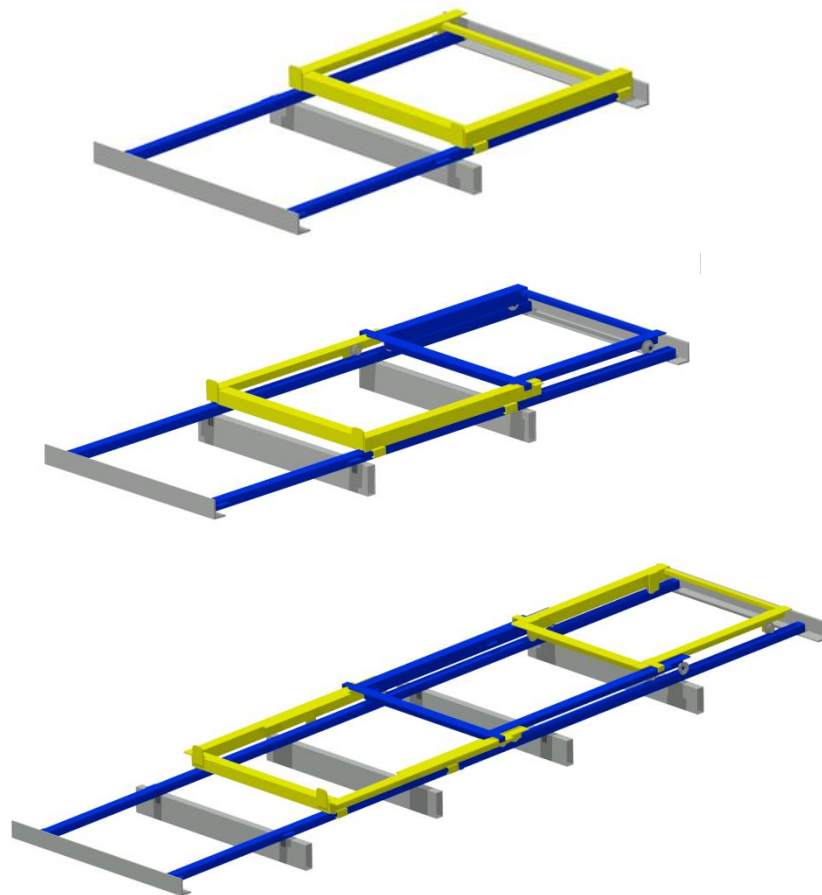

Cart Pushback System

Common Operating instructions 2-4 Pallet Places

English translation of the German original operating instructions



Contents

1	About these operating instructions	4
1.1	Introduction	4
1.2	Other applicable documents	4
1.3	Manufacturer's and service address	4
1.4	Warranty	4
1.5	Copyright	4
1.6	Text formatting features	5
2	Safety	6
2.1	Explanation of symbols	6
2.2	Intended use	7
2.3	Improper use	7
2.4	Prohibition of unauthorised modifications and alterations	7
2.5	Obligations of the operator	7
2.6	Selection and qualification of personnel	8
2.7	Notice of residual risks	8
2.8	Basic safety instructions	9
2.9	Safety devices	9
2.10	Personal protective equipment	10
3	Description	11
3.1	Overview	11
3.2	Functional description	11
3.3	Load carriers	12
	General requirements on the loading unit	12
4	Transport and storage	13
4.1	Delivery	13
4.2	Transport	13
4.3	Storage	13
5	Installation and commissioning	14
5.1	Assembly	15
	Mounting the tracks	15
	Inserting pushback trolleys	16
5.2	Commissioning	17
6	Operation	18
6.1	Loading the system	19
6.2	Unloading the system	20
7	Troubleshooting	21

8	Shutting down the system	23
9	Upkeep	24
9.1	Cleaning	25
9.2	Maintenance	25
	Maintenance schedule	25
	Maintenance record	27
9.3	Spare parts	28
	Spare parts stock	28
	Spare part orders	28
10	Decommissioning	29
10.1	Disassembly	29
10.2	Disposal	30
11	Technical specifications	31
12	Appendix	39

1 About these operating instructions

1.1 Introduction

These operating instructions will help you use the cart pushback system, hereinafter system, as intended and in a safe manner.

These operating instructions are part of the system. Keep these operating instructions close to the system where they are readily accessible. Include these operating instructions when selling or transferring the system in any other way.

1.2 Other applicable documents

These operating instructions are supplemented by additional project-specific operating instructions and technical documents. These other applicable documents are supplied together with the operating instructions at hand.

The following documents must be observed as well:

- Statutory accident prevention regulations and national regulations on health and safety in the workplace.
- Statutory provisions on environmental protection.
- In-house work instructions as well as maintenance instructions specified by the operator.

1.3 Manufacturer's and service address

Euroroll GmbH
An der Vogelrute 46b-50
59387 Ascheberg-Herbern
Germany

Tel.: +49 (0)2599 92503-0
Fax: +49 (0)2599 7300
Email: info@euroroll.de
Internet: www.euroroll.de

1.4 Warranty

Euroroll GmbH shall assume no liability for any personal injury and property damage attributable to non-observance of these operating instructions. Failure to observe these operating instructions shall also void the warranty and transfer responsibility to the operator.

1.5 Copyright

All documents are protected by copyright laws. Any transfer or duplication of documents, even in excerpts, as well as the use and disclosure of their contents shall be prohibited without express written consent. Failure to comply shall constitute grounds for prosecution and damages. All rights and the exercise of industrial property rights shall be reserved for Euroroll GmbH.

1.6 Text formatting features

Different elements in these instructions are highlighted by means of predefined formatting features. These features allow you to easily detect which type of text you are reading.



Regular text,
Cross references,

- Lists or
- Work steps.

2 Safety

2.1 Explanation of symbols

Danger notices and information are clearly marked throughout these instructions for use. The following symbols are used:

⚠ DANGER!	
	<p>Direct danger to life and risk of injury! Directly dangerous situation that may lead to death or severe injuries.</p>
⚠ WARNING!	
	<p>Probable danger to life and risk of injury! Generally dangerous situation that may lead to death or severe injuries.</p>
⚠ CAUTION!	
	<p>Possible risk of injury! Dangerous situation that may lead to injuries.</p>
ATTENTION!	
	<p>Risk of damage to the device! Situation that may lead to property damage.</p>



Notice:

Information to help you reach a better understanding of the processes involved.

The structure of hazard warnings provided in these operating instructions looks as follows:

⚠ SIGNAL WORD!	
	<p>Cause of the hazard Consequence of the hazard ➤ Measures to avert the hazard</p>

2.2 Intended use

The system is designed exclusively for the dynamic storage of the load carriers and conveyed materials specified in chapter *Technical specifications* on page 31 .

The system is **not** approved for the transport of people.

The system may only be used in commercial enterprises by personnel who have received proper training and instructions on how to operate the system.

The system may only be loaded and unloaded using suitable forklift trucks.

Intended use also includes the following requirements:

- Compliance with and observance of all information provided in these operating instructions
- Compliance with the inspection and maintenance intervals as specified in the manufacturer's documentation
- Use of suitable forklift trucks for inserting and removing load carriers

Any other use exceeding or deviating from the scope of intended use is considered improper.

2.3 Improper use

Use of the system is considered improper in the following cases:

- Use of load carriers other than those specified.
- The system is used for the transport of people.
- The system is operated by untrained personnel.
- The system is used by personnel who are not wearing the proper personal protective equipment.

Improper use of the system can lead to personal injury and property damage.

Euroroll GmbH shall not assume any liability for damage that can be attributed to improper use of the system.

2.4 Prohibition of unauthorised modifications and alterations

Do not perform any modifications and alterations on the system without proper authorisation. Modifications and alterations are prohibited without the written approval of Euroroll GmbH.

2.5 Obligations of the operator

The operator of the system is subject to the statutory regulations on health and safety in the workplace applicable at the location where the system is used. Aside from the health and safety notices included in these operating instructions, the operator is also required to observe all safety, accident prevention and environmental protection regulations applicable at the location where the system is used.

The operator is required to

- become familiar with all applicable regulations on health and safety in the workplace and determine any additional risks in the context of a risk assessment that result from the special work conditions present at the system's site of operation. The operator must incorporate the findings of this assessment into instructions on the operation of the system.
- verify throughout the entire service life of the system that the operating instructions they prepared correspond to the current revision of the applicable standards and revise them if necessary.

- define a hazard area of sufficient size around the system. The hazard area must not be accessible to unauthorised personnel while the system is in operation.
- ensure that all personnel working on the system have read and understood the operating instructions. The operator is, furthermore, required to train their personnel at regular intervals, subject them to a safety briefing and inform them about all hazards involved.
- to provide personnel with the necessary protective equipment.
- ensure that the system is only used as intended and only when in proper and fully operational condition.
- to check / inspect the system at regular intervals.
- ensure that all inspection and maintenance intervals be observed.
- ensure that the operating instructions are always available at the system's site of operation as complete and fully legible copies.
- ensure that all safety notices and warnings are never removed from the system and remain clean and in fully legible condition.
- ensure that the work area is sufficiently lit.

2.6 Selection and qualification of personnel

Qualified personnel are persons who, on the basis of their training, experience and instructions as well as their knowledge of the relevant standards, provisions, accident prevention regulations and operating conditions, have been authorised by the person responsible for safety to execute the necessary activities and who, in doing so, are able to recognise and prevent possible hazards.

The operator is required to provide for the necessary qualification of the personnel. The operator must ensure the following:

- The personnel have been made familiar with the safety regulations and the residual risks.
- The personnel have been instructed on the specific requirements regarding maintenance, control and operation of the system.
- Personnel in training may only work on the system under the supervision of qualified professional staff.

2.7 Notice of residual risks

The system has been built in compliance with the state of the art, the recognised technical safety rules and all relevant standards.

Safety hazards have been eliminated by design measures or made inaccessible by suitable fixtures. Despite these measures, certain residual risks remain during the operation of the system.

Danger to personnel / negative impact on the system and other property can arise in the following cases:

- The system is operated by personnel who have not been properly trained or instructed.
- The system is not operated as intended.
- The system is improperly serviced or cleaned.

2.8 Basic safety instructions

Avoiding general hazards

The system has been built and made safe to operate in accordance with the state of the art. The system is in conformity with all applicable requirements on health and safety.

As a prerequisite for safety, the following safety regulations must be observed by both the operator of the system and their personnel:







- The personnel assigned to work on the system must have read and understood these operating instructions.
- The regulations on environmental protection as well as health and safety applicable at the system's site of operation must be observed.
- All included supplier documents must be followed as well.
- The operator must make all applicable regulations available and train the personnel entrusted to work with the system accordingly.
- All work on the system may only be performed by personnel who have been given proper authorisation.
- The system may only be operated as intended.
- The system must not be operated unless in proper technical condition.
- All safety notices and warnings attached to the system must be observed and kept in legible condition at all times.
- All work on the system requires that personnel wear the personal protective equipment necessary.
- Never reach into any moving parts.
- Never step onto the conveyor.
- Any faults affecting the safety of the personnel or the system must be eliminated without delay.
- Protective devices and monitoring equipment must never be modified or removed.
- The specified maintenance intervals must be observed.
- The system may only be operated by qualified, trained and instructed professional staff. The operating personnel must ensure that unauthorised personnel are kept away from the system area.
- Work for the purpose of servicing / troubleshooting the system may only be performed by qualified, trained and instructed professional staff.
- Cleaning, maintenance and repair operations must not be performed unless the system is shut down.
- When maintenance is complete, all loosened screw connections must be re-tightened to the necessary torque.

2.9 Safety devices

Safety devices are intended to help exclude personal injury and property damage. The system must not be operated unless all safety devices are present and fully operational.

2.10 Personal protective equipment

Wearing personal protective equipment during work is mandatory to minimise risks. The protective equipment necessary for the respective work must be worn at all times. The symbols signify the following:

Symbol	Description
	<p>Protective work clothing</p> <p>Tight-fitting work clothes with low resistance to tearing, narrow sleeves and without any protruding parts. It is designed primarily to protect against becoming caught in the moving parts of the system.</p> <p>Do not wear rings, chains or other types of jewellery.</p>
	<p>Safety boots</p> <p>For protection against heavy parts falling down and from slipping on slick surfaces.</p>
	<p>Protective gloves</p> <p>For protecting the hands against abrasions, puncture or deeper injuries and from irritating and caustic substances as well as burns.</p>
	<p>Hard hat</p> <p>For protection against heavy parts falling down and for preventing injuries.</p>
	<p>Hearing protection</p> <p>For protecting the auditory system against excessively intense noise.</p>
	<p>No admittance to unauthorised personnel!</p> <p>This prohibitory sign indicates that non-authorised personnel are prohibited from entering the area around the system.</p>

3 Description

3.1 Overview

The cart pushback system is a system used for storing load carriers based on the LIFO principle (Last In, First Out). The cart pushback system is made up of moving pushback trolleys and tracks. The system is suited for installation in a rack.

The pushback trolley consists of several interlinked trolleys which vary with the number of storage spaces in the channel and which can be pushed one on top the other when unladen.

The cart pushback system is made up of the following components:

- Tracks
- Pushback trolleys

The tracks are installed in pairs and with a certain declination inside a channel. Located on the outside of the tracks are guides for anti-removal protection.

The pushback trolleys are guided along the tracks on rollers. The anti-removal protection on the bottom trolley prevents the trolley from being lifted off the tracks by accident. In a set-up with multiple pushback trolleys, a spread stopper prevents the trolley from being bent out of shape under load. The stop plates on the trolley prevent the load carrier from slipping off the trolley.

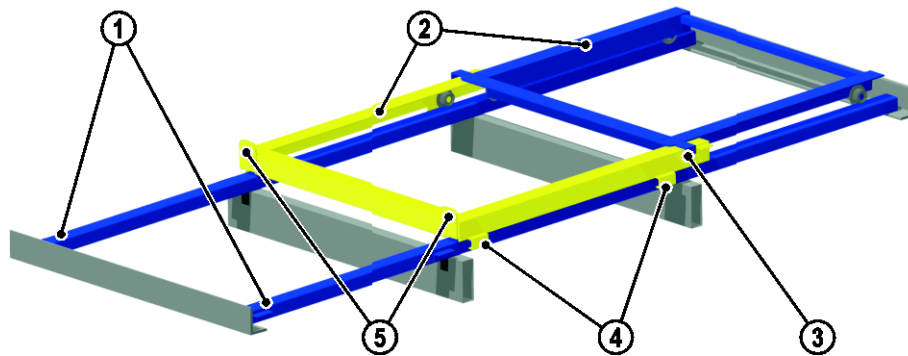

Cart pushback system with three storage spaces (schematic diagram)

1. Tracks
2. Pushback trolleys
3. Spread stopper
4. Anti-removal protection
5. Stop plates

3.2 Functional description

During loading, the first pallet is set down on the topmost trolley using a forklift truck. When the next pallet is inserted, all pallets already loaded in the channel are pushed back by one space on their trolley. The next pallet to be set down is positioned on the next lower trolley. The last pallet is set down directly on the tracks.

During unloading, a forklift truck lifts the front pallet slightly past the stop before slowly driving backward. The remaining pallets in the channel roll forward against the stop at the forklift truck's rate of speed.

3.3 Load carriers

The system is designed for use with one of the load carriers listed below:

- Euro pallet
- Industrial pallet
- CHEP pallet UK
- US pallet GMA



Notice:

For more detailed information, refer to the chapter *Technical specifications* on page 31.

General requirements on the loading unit

The load carrier and the goods transported on it make up the loading unit*. It must meet the following requirements:

- The dimensions of the loading unit must correspond to the project-related specifications.
- The min./max. weight and the maximum dimensions must not be exceeded.
- The goods on the load carrier must be secured in such a way that any damage during transport from the goods shifting or falling down is reliably prevented.
- The runners of the load carriers must not have any protruding nails or other interfering edges.
- The runners must not be splintered or broken.
- There must not be any film or strapping under the runners.
- The residual moisture in the wooden pallets should be no more than 7% to 15%.

*If the loading unit is governed by a standard, this standard must be observed as well

Examples of poor pallet quality



Pallet quality

1. Middle runner missing, film under the runner
2. Pallet destroyed, middle runner broken
3. Middle runner splintered



Notice:

Load carriers showing severe damage must not be brought into store circulation.



Notice:

Load carriers showing severe damage must not be brought into store circulation.



4 Transport and storage

4.1 Delivery

The cart pushback system was packaged for the selected type of transport in such a way that damage can be excluded to the greatest possible extent.

- Check the shipment for completeness and damage based on the shipping documents.
- Pay particular attention to pieces of equipment that have been included as loose parts.
- If detecting any defects, notify the manufacturer and, in case of transport damage, also the carrier immediately in writing.

4.2 Transport





⚠ WARNING!	
	<p>Suspended loads, falling parts!</p> <p>Falling parts may lead to serious injuries.</p> <ul style="list-style-type: none"> ➤ Use only approved crane systems and lifting equipment of adequate size and capacity. ➤ Use special aids (e.g. beams) if required. ➤ To protect ropes and chains against damage and tearing, use an edge guard if the sling gear is guided across the edges of packaging or machines. ➤ Secure parts against shifting during transport. ➤ Take into account that the centre of gravity will shift during transport. ➤ Stay out from under suspended loads.
⚠ WARNING!	
	<p>Tipping or falling parts!</p> <p>Tipping or falling parts may result in serious injuries.</p> <ul style="list-style-type: none"> ➤ Never stand under or directly next to suspended loads. ➤ Observe the bearing capacity of the means of transport. ➤ Determine the component's centre of gravity. ➤ Secure the parts against shifting during transport.

The components of the cart pushback system are delivered as separate units. Each unit can be transported using a forklift or manual pallet jack. The minimum bearing capacity of the transport and lifting equipment must correspond to the weight of the packing piece.

4.3 Storage

- The storage location must be dry and protected against dust, dirt and vibrations.
- The packing pieces are not suited for outdoor storage.
- If stored outdoors, the packing pieces must be protected against adverse weather conditions by additional means.

5 Installation and commissioning

⚠ WARNING!	
	<p>Fall/plunge from the top levels of the system!</p> <p>Risk of injuries due to falls from the top levels of the system.</p> <ul style="list-style-type: none"> ➤ Allow only qualified professional staff to work on the top levels of the system. ➤ Always wear fall arresting devices / safety harnesses. ➤ Wear personal protective equipment. ➤ Before inspecting the system, make sure the channel to be inspected is blocked. ➤ Use suitable aids to drive along the channel, e.g. maintenance pallet, elevating work platform.
⚠ WARNING!	
	<p>Unsecured system!</p> <p>Risk of injury if the system is unsecured during installation and disassembly work.</p> <ul style="list-style-type: none"> ➤ The system must be secured using, for example, caution tape. ➤ Make sure that no unauthorised personnel have access to the work area.
⚠ WARNING!	
	<p>Suspended loads, falling parts!</p> <p>Falling parts may lead to serious injuries.</p> <ul style="list-style-type: none"> ➤ Use only approved crane systems and lifting equipment of adequate size and capacity. ➤ Use special aids (e.g. beams) if required. ➤ To protect ropes and chains against damage and tearing, use an edge guard if the sling gear is guided across the edges of packaging or machines. ➤ Secure parts against shifting during transport. ➤ Take into account that the centre of gravity will shift during transport. ➤ Stay out from under suspended loads.
⚠ CAUTION!	
	<p>Moving parts!</p> <p>Risk of crushing injuries at moving parts.</p> <ul style="list-style-type: none"> ➤ Wear personal protective equipment. ➤ Keep at a distance. ➤ Do not reach into the system.

5.1 Assembly



Notice:

Always use the assembly drawings include with the order as an installation aid; see chapter *Appendix* from page 39.



Notice:

Pay attention to the following when assembling the cart pushback system:

- The rack frame into which the cart pushback system will be installed has already been erected.
- The beams must be mounted so that they create a uniform declination of 3%.
- The beam used at the front must be an angle beam.
- The beam used at the rear can be either an angle beam or a box beam.
- Transport the tracks to the channel using a forklift.
- Perform the track installation from the topmost to the bottommost channel.

Mounting the tracks

1. Insert the left and the right track into the channel.
Make sure the anti-removal protection devices are fitted on the outside.
2. Use the threaded inserts (2) to affix the tracks to the front angle beam (1).

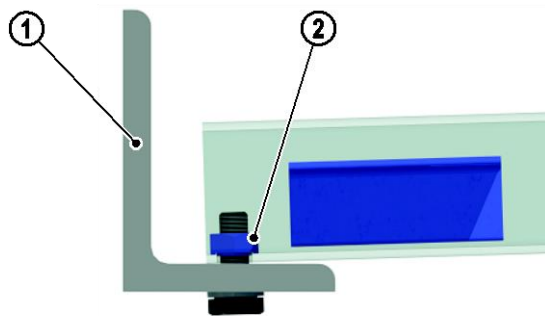

Track attachment at the front (schematic diagram)

3. a) When using an angle beam at the rear of the system:
Use the threaded inserts (3) to affix the tracks to the rear angle beam (4).
- b) When using a box beam at the rear of the system:
Use mounting brackets (5) and drilling screws (6) to affix the tracks to the box beam (7).

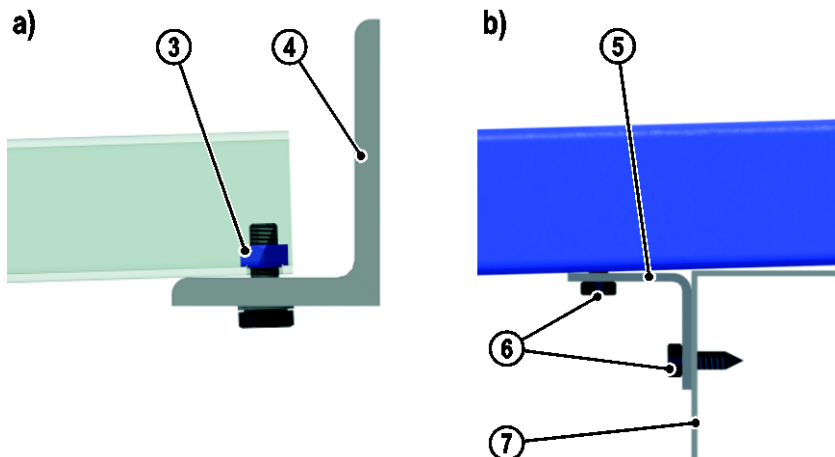

Track attachment at the rear (schematic diagram)

4. Check the track spacing.
5. Use mounting brackets and drilling screws or attachment hooks to affix the tracks to the remaining beams and check the track spacing.

Inserting pushback trolleys

1. Place the bottom pushback trolley (2) on the tracks immediately behind the anti-removal protection (3). Make sure the stop plates (1) are on the front side.

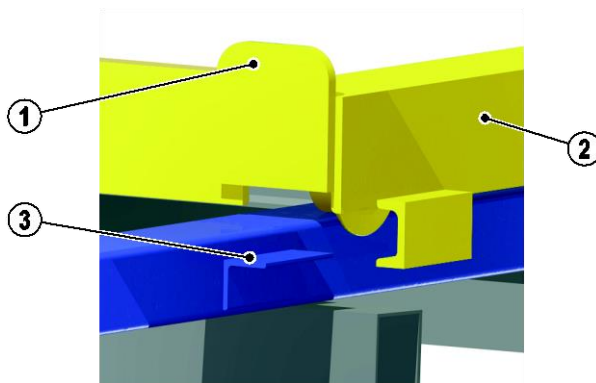

Inserting pushback trolleys (schematic diagram)

2. Let the pushback trolley run forward. The hooks (5) on the trolley must encompass the anti-removal protection (4) without touching it.

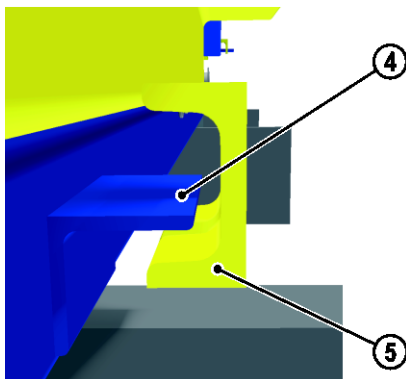

Anti-removal protection (schematic diagram)

3. Place the other pushback trolleys on the tracks one at a time. While placing the trolleys, make sure the spread stopper (6) meshes with the trolley underneath.

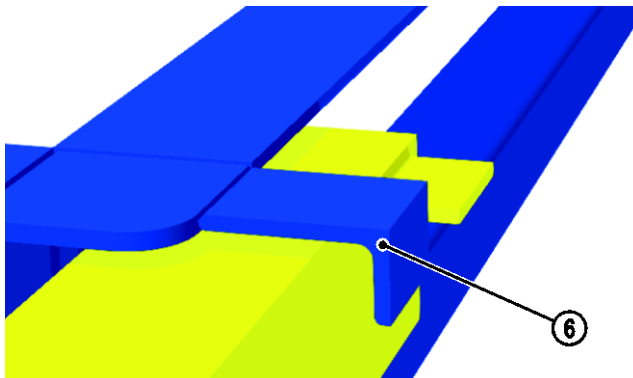

Spread stopper (schematic diagram)

4. Pull the topmost trolley (7) back all the way. The remaining trolleys will follow as they are interconnected by the spread stopper.

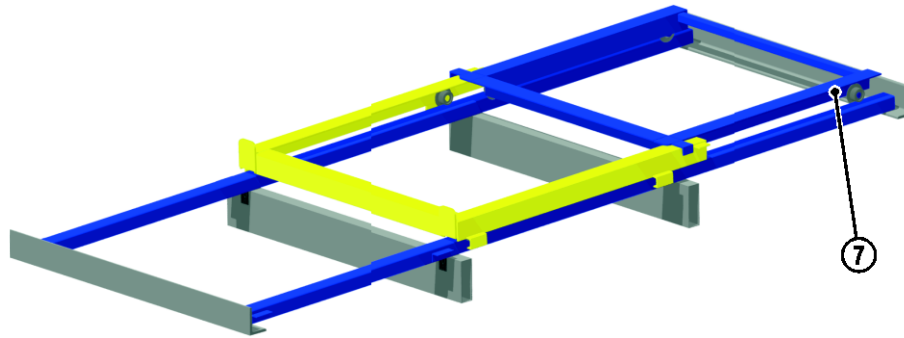

Pulling apart the pushback trolleys (schematic diagram)

5. Release the trolley and observe its running performance. The trolleys are supposed to gently return to their initial position.





Pushback trolleys, initial position (schematic diagram)

5.2 Commissioning

The system can be put into operation when it has been ensured that

- all foreign materials have been removed from the system.
- all safety devices have been fitted and checked for their proper operation.
- all screw connections have been checked for secure seating.
- the running performance of the pushback trolleys is in order.

6 Operation

⚠ WARNING!	
	<p>The conveyed material will move while on the system!</p> <p>There is a risk of sustaining severe crushing injuries from reaching between conveyed material and stationary structural elements.</p> <ul style="list-style-type: none"> ➤ Wear personal protective equipment. ➤ Do not reach into the system during operation. ➤ Keep at a distance.
⚠ CAUTION!	
	<p>Risk of injury from falling pallets!</p> <p>Improper handling while loading and unloading the system can lead to injury.</p> <ul style="list-style-type: none"> ➤ Load and unload the system from the front. ➤ Use only pallets that have been designed for the system. ➤ Use and remove pallets at a constant rate of speed. During unloading, the forklift must hold back the subsequent pallets until they make contact with the stop. ➤ Do not insert pallets into the channel if all spaces are occupied. The channel is full when the stop plates on the pushback trolleys are no longer visible. ➤ Do not insert a pallet into the channel unless it fits in the channel completely. ➤ Remove any protruding pallets immediately.
⚠ CAUTION!	
	<p>Moving parts!</p> <p>Risk of crushing injuries at moving parts.</p> <ul style="list-style-type: none"> ➤ Wear personal protective equipment. ➤ Keep at a distance. ➤ Do not reach into the system.
ATTENTION!	
	<p>Risk of damage to the system and the load!</p> <p>Improper loading and unloading can result in damage to the system and the load.</p> <ul style="list-style-type: none"> ➤ Use caution when loading and unloading the system. ➤ Avoid slamming down or dropping the pallet. ➤ Do not touch pushback trolleys and tracks with the fork. ➤ Do not use pallets whose loads have become wedged into each other.



Notice:

Loading and unloading the system requires the use of forklift trucks with tilting mast/fork.

The forks must match the depth of the pallet and not protrude.

6.1 Loading the system

Placing the first pallet

- Align and centre the pallet on the channel using the forklift.
- Adjust the fork to the channel's declination of 3 %.
- Raise the pallet just over the stop plates on the pushback trolley.
- Drive the pallet straight into the channel and set it down carefully on the topmost pushback trolley behind the stop plates.

The pallet must not project towards the front.

- Carefully back up the forklift while returning the fork to the horizontal position. Do not touch the pushback trolley.

Placing additional pallets

- Align and centre the pallet on the channel using the forklift.
- Adjust the fork to the channel's declination of 3 %.
- Raise the pallet just over the stop plates on the pushback trolley.
- Drive the pallet into the channel. While doing so, use the pallet to carefully push back the pallet already in the channel including its pushback trolley until the pallet on the fork can be set down on the next pushback trolley.
- Set down the pallet on the pushback trolley behind the stop plates.

The pallet must not project towards the front.

- Carefully back up the forklift while returning the fork to the horizontal position. Do not touch the pushback trolley.

Placing the last pallet

- Align and centre the pallet on the channel using the forklift.
- Adjust the fork to the channel's declination of 3 %.
- Raise the pallet just over the front angle beam on the rack.
- Drive the pallet into the channel. While doing so, use the pallet to carefully push back the pallets already in the channel including their pushback trolley until the pallet on the fork can be set down on the tracks.
- Set down the pallet on the tracks behind the angle beam.

The pallet must not project towards the front.

- Carefully back up the forklift while returning the fork to the horizontal position. Do not touch the pushback trolley.



Notice:

When the stop plates on the front side are no longer visible, all spaces in the channel are occupied.

6.2 Unloading the system

Removing the pallet from the tracks

- Align the forklift with the channel.
- Drive up to the channel with the fork in the horizontal position before setting the tilt of the fork to 3 % while driving into the channel. Do not touch the pushback trolley.
- Raise the pallet to approx. 50 mm above the angle beam.
- Carefully and evenly back up the forklift at no more than 0.3 m/s.

The forklift regulates the speed of the following pushback trolleys. Select a rate of speed that keeps the pallets in constant contact.

- Maintain the speed until the following pallet on the pushback trolley makes contact with the angle beam.



Removing pallets from the pushback trolleys

- Align the forklift with the channel.
- Drive up to the channel with the fork in the horizontal position before setting the tilt of the fork to 3 % while driving into the channel. Do not touch the pushback trolley.
- Raise the pallet to approx. 50 mm above the stop plates on the pushback trolley.
- Carefully and evenly back up the forklift at no more than 0.3 m/s.

The forklift regulates the speed of the following pushback trolleys. Select a rate of speed that keeps the pallets in constant contact.

- Maintain the speed until the following pallet on the pushback trolley makes contact with the stop plates.

7 Troubleshooting

⚠ WARNING!	
	<p>The pushback trolleys move while in the system!</p> <p>Risk of injury from pushback trolleys in motion or pushback trolleys starting to move again.</p> <ul style="list-style-type: none"> ➤ Allow only qualified professional staff to perform troubleshooting operations. ➤ Do not stop pushback trolleys that are in motion. ➤ Do not release pushback trolleys that have become wedged by hand. ➤ Wear personal protective equipment.
⚠ WARNING!	
	<p>Unsecured system!</p> <p>Severe injuries if the system is unsecured during troubleshooting.</p> <ul style="list-style-type: none"> ➤ Make sure that the system is shut down before performing troubleshooting operations. ➤ The system must be secured using, for example, caution tape. ➤ Make sure that no unauthorised personnel have access to the work area.
⚠ WARNING!	
	<p>Fall/plunge from the top levels of the system!</p> <p>Risk of injuries due to falls from the top levels of the system.</p> <ul style="list-style-type: none"> ➤ Allow only qualified professional staff to work on the top levels of the system. ➤ Always wear fall arresting devices / safety harnesses. ➤ Wear personal protective equipment. ➤ Before inspecting the system, make sure the channel to be inspected is blocked. ➤ Use suitable aids to drive along the channel, e.g. maintenance pallet, elevating work platform.



Notice:

If a load carrier stops, the cause behind the stop is not necessarily an error in the system. Inserting the next load carrier usually restores regular operation.

The overview below lists possible causes behind faults as well as information on how to remedy these faults.

Fault	Cause	Remedy
Pushback trolley is stuck	Pallet is damaged	➤ Remove the pallet from store circulation
	Uneven load distribution on the pallet	➤ Repack the pallet
	Film or strapping under the runners	➤ Remove film or strapping from under the runners
	Pallet does not correspond to the order specifications	➤ Remove the pallet from store circulation
	Foreign materials on the tracks	➤ Remove foreign materials
	Track spacing is unequal	➤ Check the attachment of the tracks ➤ Replace damaged tracks
	Tracks damaged	➤ Replace damaged tracks
	Wheel defective	➤ Replace defective wheel
	Anti-removal protection or spread stopper bent	➤ Straighten the stopper ➤ Replace tracks / pushback trolleys if they show signs of extensive material fatigue





8 Shutting down the system

The system must be shut down prior to cleaning and maintenance and before being taken out of service.

Proceed as follows:

- Remove all load carriers.
- Cordon off the system.

9 Upkeep

⚠ WARNING!	
	<p>Unsecured system!</p> <p>Severe injuries if the system is unsecured during cleaning and maintenance.</p> <ul style="list-style-type: none"> ➤ Make sure that the system is shut down prior to cleaning and maintenance. ➤ The system must be secured using, for example, caution tape. ➤ Make sure that no unauthorised personnel have access to the work area.
⚠ WARNING!	
	<p>Fall/plunge from the top levels of the system!</p> <p>Risk of injuries due to falls from the top levels of the system.</p> <ul style="list-style-type: none"> ➤ Allow only qualified professional staff to work on the top levels of the system. ➤ Always wear fall arresting devices / safety harnesses. ➤ Wear personal protective equipment. ➤ Before inspecting the system, make sure the channel to be inspected is blocked. ➤ Use suitable aids to drive along the channel, e.g. maintenance pallet, elevating work platform.
⚠ WARNING!	
	<p>The conveyed material will move while on the system!</p> <p>There is a risk of sustaining severe crushing injuries from reaching between conveyed material and stationary structural elements.</p> <ul style="list-style-type: none"> ➤ Wear personal protective equipment. ➤ Do not reach into the system during operation. ➤ Keep at a distance.
⚠ CAUTION!	
	<p>Moving parts!</p> <p>Risk of crushing injuries at moving parts.</p> <ul style="list-style-type: none"> ➤ Wear personal protective equipment. ➤ Keep at a distance. ➤ Do not reach into the system.
ATTENTION!	
	<p>Risk of equipment damage!</p> <p>Improper cleaning can lead to damage or corrosion on the system.</p> <ul style="list-style-type: none"> ➤ Do not use abrasive agents, pressure washers or other means that may cause damage to the system.

9.1 Cleaning

The system must be inspected regularly for contamination and foreign materials. The system must be cleaned if heavily contaminated or soiled by foreign materials.

- Shut down the system; see chapter *Shutting down the system* on page 23.
- Remove foreign materials from the system.
- Clean the system with a dry cloth.
- Keep the floor clean in the area of the system.

9.2 Maintenance

Maintenance schedule

The specified maintenance intervals apply if the system is used in single shift operation. Shorten the maintenance intervals if the system is used under heavy-duty conditions or in multi-shift operation.

Assembly	Activity	Interval				
		daily	weekly	monthly	semi-annually	annually
Cart Pushback System						
Cart Pushback System	Visual inspection for cleanliness and foreign materials. Clean the system if soiled, remove foreign materials					
Screw connections	Check if all screw connections are securely tightened; re-tighten loose connections					
Tracks	Visual inspection for external damage (bulges, dents). Replace damaged tracks					
	Check the track spacing. Find the cause if the track spacing is unequal (screw connection loose, track damaged). Replace damaged components					
Pushback trolleys	Visual inspection for external damage. Replace damaged components					
	Visual inspection for completeness (stops, rollers). Replace missing components					
	Check running performance. Correct irregular operation after determining its cause					

Assembly	Activity	Interval				
		daily	weekly	monthly	semi-annually	annually
Safety devices	Check condition and operation. Replace damaged components					

- Document all maintenance operations in a maintenance record. Refer to the next page for a template.

9.3 Spare parts

All spare parts used on the system must be spare parts delivered / expressly approved by Euroroll GmbH. Euroroll GmbH will not assume any warranty or liability for damage that can be attributed to the use of non-original spare parts.

Spare parts stock

To ensure the continuous operation of the system and maintain the capacity to tide over extended delivery times, we recommend that you keep a sufficient stock of spare and wear parts.

Spare part orders

You can order original spare parts from Euroroll's customer service department. You will find the service address on page 4.

For lists of spare and wear parts, refer to the corresponding drawings included in the appendix.



To allow for the quick and correct processing of your spare part order, we ask that you submit the following information:

1. Designation of your system
2. Year of manufacture
3. Order confirmation number (R-)
4. Item number
5. Designation and, if applicable, drawing/article no.
6. Order quantity
7. Shipping address

10 Decommissioning

This chapter provides you with important information on how to disassemble and dispose of the system. This information applies in the following situations:

- The system is set up in a different location.
- The system is put into storage.
- The system is scrapped.

⚠ WARNING!	
	<p>Unsecured system!</p> <p>Risk of injury if the system is unsecured during installation and disassembly work.</p> <ul style="list-style-type: none"> ➤ The system must be secured using, for example, caution tape. ➤ Make sure that no unauthorised personnel have access to the work area.
⚠ WARNING!	
	<p>Fall/plunge from the top levels of the system!</p> <p>Risk of injuries due to falls from the top levels of the system.</p> <ul style="list-style-type: none"> ➤ Allow only qualified professional staff to work on the top levels of the system. ➤ Always wear fall arresting devices / safety harnesses. ➤ Wear personal protective equipment. ➤ Before inspecting the system, make sure the channel to be inspected is blocked. ➤ Use suitable aids to drive along the channel, e.g. maintenance pallet, elevating work platform.

10.1 Disassembly

Observe the following rules when disassembling the system:

- Follow all safety instructions.
- Observe the regulations on accident prevention.
- Make sure that no unauthorised person is in the area of the system to be dismantled.
- Always wear safety boots when handling heavy components.
- Always wear protective gloves when handling sharp-edged components.

10.2 Disposal

The environmentally compatible disposal of operating supplies, electronic assemblies, reusable materials and other components of the system is governed by national and regional legislation. Turn to the local authority responsible for your area to obtain specific information on disposal. Contact Euroroll's customer service if you have any questions on the materials used. All parts must be sorted for environmentally compatible disposal.

Sort the parts by the materials of which they are made:

- Electronic scrap
- Metals
- Plastics
- Fluids
- Hazardous waste

Recycling

- Recycle all parts that are suitable for reuse.

11 Technical specifications

Channel for storing two pallets

Type of pallet:	Euro pallet (EUR1)
Pallet dimensions:	800 × 1200 mm
Pallet weight:	max. 1300 kg
Storage direction:	crosswise, 800 mm
System depth (min.): ⁽¹⁾ (Length of tracks for angle beam on both sides)	1700 mm
System width (max.): ⁽²⁾	1160 mm
System height ⁽³⁾ Top edge stop: Top edge last cart:	151 mm 138 mm
Weight:	42 kg
Declination of the channel (recommendation):	3 %

(1) Length of track = 2x depth of the pallet + 100 mm

(2) Greatest width = width of the pallet - 40 mm

(3) measured from the bottom edge of the angle beam

Type of pallet:	Industrial pallet (EUR3)
Pallet dimensions:	1000 × 1200 mm
Pallet weight:	max. 1300 kg
Storage direction:	crosswise, 1000 mm
System depth (min.): ⁽¹⁾ (Length of tracks for angle beam on both sides)	2100 mm
System width (max.): ⁽²⁾	1160 mm
System height ⁽³⁾ Top edge stop: Top edge last cart:	151 mm 138 mm
Weight:	48 kg
Declination of the channel (recommendation):	3 %

(1) Length of track = 2x depth of the pallet + 100 mm

(2) Greatest width = width of the pallet - 40 mm

(3) measured from the bottom edge of the angle beam

Type of pallet:	CHEP pallet UK B1210A
Pallet dimensions:	1000 × 1200 mm
Pallet weight:	max. 1300 kg
Storage direction:	crosswise, 1000 mm
System depth (min.): ⁽¹⁾ (Length of tracks for angle beam on both sides)	2100 mm
System width (max.): ⁽²⁾	1160 mm
System height ⁽³⁾ Top edge stop: Top edge last cart:	151 mm 138 mm
Weight:	48 kg
Declination of the channel (recommendation):	3 %

- (1) Length of track = 2x depth of the pallet + 100 mm
 (2) Greatest width = width of the pallet - 40 mm
 (3) measured from the bottom edge of the angle beam

Type of pallet:	CHEP pallet UK B1210A
Pallet dimensions:	1000 × 1200 mm
Pallet weight:	max. 1300 kg
Storage direction:	lengthwise, 1200 mm
System depth (min.): ⁽¹⁾ (Length of tracks for angle beam on both sides)	2500 mm
System width (max.): ⁽²⁾	960 mm
System height ⁽³⁾ Top edge stop: Top edge last cart:	151 mm 138 mm
Weight:	53 kg
Declination of the channel (recommendation):	3 %

- (1) Length of track = 2x depth of the pallet + 100 mm
 (2) Greatest width = width of the pallet - 40 mm
 (3) measured from the bottom edge of the angle beam

Type of pallet:	US pallet GMA
Pallet dimensions:	1220 × 1220 mm
Pallet weight:	max. 1300 kg
Storage direction:	→, 1220 mm
System depth (min.): ⁽¹⁾ (Length of tracks for angle beam on both sides)	2540 mm
System width (max.): ⁽²⁾	1180 mm
System height ⁽³⁾ Top edge stop: Top edge last cart:	151 mm 138 mm
Weight:	56 kg
Declination of the channel (recommendation):	3 %

- (1) Length of track = 2x depth of the pallet + 100 mm
 (2) Greatest width = width of the pallet - 40 mm
 (3) measured from the bottom edge of the angle beam

Channel for storing three pallets

Type of pallet:	Euro pallet (EUR1)
Pallet dimensions:	800 × 1200 mm
Pallet weight:	max. 1300 kg
Storage direction:	crosswise, 800 mm
System depth (min.): ⁽¹⁾ (Length of tracks for angle beam on both sides)	2500 mm
System width (max.): ⁽²⁾	1180 mm
System height ⁽³⁾ Top edge stop: Top edge last cart:	164 mm 151 mm
Weight:	76 kg
Declination of the channel (recommendation):	3 %

- (1) Length of track = 3x depth of the pallet + 150 mm
 (2) Greatest width = width of the pallet - 20 mm
 (3) measured from the bottom edge of the angle beam

Type of pallet:	Industrial pallet (EUR3)
Pallet dimensions:	1000 × 1200 mm
Pallet weight:	max. 1300 kg
Storage direction:	crosswise, 1000 mm
System depth (min.): ⁽¹⁾ (Length of tracks for angle beam on both sides)	3150 mm
System width (max.): ⁽²⁾	1180 mm
System height ⁽³⁾ Top edge stop: Top edge last cart:	164 mm 151 mm
Weight:	87 kg
Declination of the channel (recommendation):	3 %

- (1) Length of track = 3x depth of the pallet + 150 mm
 (2) Greatest width = width of the pallet - 20 mm
 (3) measured from the bottom edge of the angle beam

Type of pallet:	CHEP pallet UK B1210A
Pallet dimensions:	1000 × 1200 mm
Pallet weight:	max. 1300 kg
Storage direction:	crosswise, 1000 mm
System depth (min.): ⁽¹⁾ (Length of tracks for angle beam on both sides)	3150 mm
System width (max.): ⁽²⁾	1180 mm
System height ⁽³⁾ Top edge stop: Top edge last cart:	164 mm 151 mm
Weight:	87 kg
Declination of the channel (recommendation):	3 %

- (1) Length of track = 3x depth of the pallet + 150 mm
 (2) Greatest width = width of the pallet - 20 mm
 (3) measured from the bottom edge of the angle beam

Type of pallet:	CHEP pallet UK B1210A
Pallet dimensions:	1000 × 1200 mm
Pallet weight:	max. 1300 kg
Storage direction:	lengthwise, 1200 mm
System depth (min.): ⁽¹⁾ (Length of tracks for angle beam on both sides)	3750 mm
System width (max.): ⁽²⁾	980 mm
System height ⁽³⁾ Top edge stop: Top edge last cart:	164 mm 151 mm
Weight:	96 kg
Declination of the channel (recommendation):	3 %

- (1) Length of track = 3x depth of the pallet + 150 mm
 (2) Greatest width = width of the pallet - 20 mm
 (3) measured from the bottom edge of the angle beam

Type of pallet:	US pallet GMA
Pallet dimensions:	1220 × 1220 mm
Pallet weight:	max. 1300 kg
Storage direction:	–, 1220 mm
System depth (min.): ⁽¹⁾ (Length of tracks for angle beam on both sides)	3810 mm
System width (max.): ⁽²⁾	1200 mm
System height ⁽³⁾ Top edge stop: Top edge last cart:	164 mm 151 mm
Weight:	100 kg
Declination of the channel (recommendation):	3 %

- (1) Length of track = 3x depth of the pallet + 150 mm
 (2) Greatest width = width of the pallet - 20 mm
 (3) measured from the bottom edge of the angle beam

Channel for storing four pallets

Type of pallet:	Euro pallet (EUR1)
Pallet dimensions:	800 × 1200 mm
Pallet weight:	max. 1300 kg
Storage direction:	crosswise, 800 mm
System depth (min.): ⁽¹⁾ (Length of tracks for angle beam on both sides)	3400 mm
System width (max.): ⁽²⁾	1307 mm
System height ⁽³⁾ Top edge stop: Top edge last cart:	189 mm 176 mm
Weight:	118 kg
Declination of the channel (recommendation):	3 %

- (1) Length of track = 4x depth of the pallet + 200 mm
 (2) Greatest width = width of the pallet + 107 mm
 (3) measured from the bottom edge of the angle beam

Type of pallet:	Industrial pallet (EUR3)
Pallet dimensions:	1000 × 1200 mm
Pallet weight:	max. 1300 kg
Storage direction:	crosswise, 1000 mm
System depth (min.): ⁽¹⁾ (Length of tracks for angle beam on both sides)	4200 mm
System width (max.): ⁽²⁾	1307 mm
System height ⁽³⁾ Top edge stop: Top edge last cart:	189 mm 176 mm
Weight:	135 kg
Declination of the channel (recommendation):	3 %

- (1) Length of track = 4x depth of the pallet + 200 mm
 (2) Greatest width = width of the pallet + 107 mm
 (3) measured from the bottom edge of the angle beam

Type of pallet:	CHEP pallet UK B1210A
Pallet dimensions:	1000 × 1200 mm
Pallet weight:	max. 1300 kg
Storage direction:	crosswise, 1000 mm
System depth (min.): ⁽¹⁾ (Length of tracks for angle beam on both sides)	4200 mm
System width (max.): ⁽²⁾	1307 mm
System height ⁽³⁾ Top edge stop: Top edge last cart:	189 mm 176 mm
Weight:	135 kg
Declination of the channel (recommendation):	3 %

- (1) Length of track = 4x depth of the pallet + 200 mm
 (2) Greatest width = width of the pallet + 107 mm
 (3) measured from the bottom edge of the angle beam

Type of pallet:	CHEP pallet UK B1210A
Pallet dimensions:	1000 × 1200 mm
Pallet weight:	max. 1300 kg
Storage direction:	lengthwise, 1200 mm
System depth (min.): ⁽¹⁾ (Length of tracks for angle beam on both sides)	5000 mm
System width (max.): ⁽²⁾	1107 mm
System height ⁽³⁾ Top edge stop: Top edge last cart:	189 mm 176 mm
Weight:	145 kg
Declination of the channel (recommendation):	3 %

- (1) Length of track = 4x depth of the pallet + 200 mm
 (2) Greatest width = width of the pallet + 107 mm
 (3) measured from the bottom edge of the angle beam

Type of pallet:	US pallet GMA
Pallet dimensions:	1220 x 1220 mm
Pallet weight:	max. 1300 kg
Storage direction:	→, 1220 mm
System depth (min.): ⁽¹⁾ (Length of tracks for angle beam on both sides)	5080 mm
System width (max.): ⁽²⁾	1327 mm
System height ⁽³⁾ Top edge stop: Top edge last cart:	189 mm 176 mm
Weight:	153 kg
Declination of the channel (recommendation):	3 %

(1) Length of track = 4x depth of the pallet + 200 mm

(2) Greatest width = width of the pallet + 107 mm

(3) measured from the bottom edge of the angle beam

Tightening torque levels of screw connections

Screw connection	Dimension	Tightening torque
Track – angle beam	M _	__ Nm
Track – mounting bracket	M _	__ Nm
Mounting bracket - box beam	M _	__ Nm

Environmental conditions

Installation location	Hall, heated
Permissible temperature, operation	__ - __ °C
Permissible temperature, storage	__ - __ °C
Humidity	max. __ %

12 Appendix

In the appendix you will find the following documents:

- Drawings
- Information on spare parts
- Tightening torques in Nm for screw strength class

**Metainformationen zum Dokument
(diese Seite nicht mit der Betriebsanleitung weitergeben)**

Auf dieser Seite werden Textmarken definiert, welche im gesamten Dokument mehrfach innerhalb von automatisch generierten Feldern (Querverweisen) verwendet werden. Achtung, eckige Klammern nicht löschen!

Feld	Beispiele	Eingabe
Benennung	Schwerkraftrollenbahn Cart Push Back System	Cart Pushback System
Ausgabedatum	01.12.2016	06.03.2017

Vorgehensweise:

In der rechten Spalte Doppelklick auf den Text zwischen den eckigen Klammern ausführen.

Es öffnet sich ein Fenster:

Im Eingabefeld „Standardtext:“ vorhandene Eingabe mit neuer Eingabe überschreiben, anschließend mit OK bestätigen.

Damit die neue Eingabe an den entsprechenden Stellen angezeigt wird, einmal in die Druckansicht wechseln (Felder aktualisieren)

Thread	Tightening torques in Nm for screw strength class				
	5.6	6.9	8.8	10.9	12.9
M 2		0,31	0,38	0,56	0,65
M 3	0,62	0,99	1,3	1,9	2,2
M 4	1,4	2,3	2,9	4,1	4,9
M 5	2,8	4,5	6	8,5	10
M 6	4,8	7,7	10	14	17
M 8	12	19	25	35	41
M10	23	37	49	69	83
M12	40	65	86	120	145
M14	64	105	135	190	230
M16	98	155	210	295	355
M18	135	215	290	405	485
M20	190	305	410	580	690
M22	260	415	550	780	930
M24	330	530	710	1000	1200